

## Bimetal-thermometer Heavy Duty

Accuracy class 1

process connection lower mount



### Description

These types of thermometers have been developed for industrial applications. Case, ring and stem are made of stainless steel.

The measuring element of the bimetal thermometer is a quick reacting bimetal coil. It is manufactured from two cold-welded metal strips with different thermal expansion coefficients and rotates in proportion to temperature. The rotary movement is conveyed to the pointer with low friction.

A comprehensive range of standard versions enables a wide range of applications and uses. Special versions are also manufactured to customer specifications.

### Features

- Short response time
- Wide selection of standard versions
- Special versions to customer specifications

### Ranges / Options

-30 ... 50 °C to 0 ... 500°C

### Applications

Machine construction,  
Container and pipe construction,  
building services and  
a wide range of applications in industry

**Models: TM216, TM217, TM218, TM219**

## Technical Data

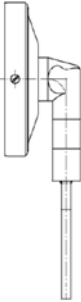
Models	TM216	TM217	TM218	TM219
				
Nominal size (mm)	63	80	100	160
Accuracy	Class 1 acc. to EN13190			
Display range	Display range [°C]	Measuring range [°C]	Max. error [°C]	
Measuring range	-30 ... 50	-20 ... 40	± 1	
Max. error	-20 ... 60	-10 ... 50	± 1	
	0 ... 60	10 ... 50	± 1	
	0 ... 120	10 ... 110	± 2	
	0 ... 160	20 ... 140	± 2	
	0 ... 200	20 ... 180	± 2	
	0 ... 250	30 ... 220	± 2,5	
	0 ... 300	30 ... 270	± 5	
	0 ... 400	50 ... 350	± 5	
	0 ... 500	50 ... 450	± 5	
Range of use	Constant load: Measuring range Short-time (≤ 1h): Display range			
Process connection (stem)	Lower mount			
Design of connection	Plain stem Standard, male thread Male nut Union nut Compression fitting, sliding on stem			
material of case / ring / stem	Stainless steel			
Window	Flat instrument glas			
dial	Aluminium matfinishedt, with fine graduation, Skale and marking black			
Measuring element	Bimetal coil			
Pointer	Aluminium black, adjustable pointer			
Protection class	IP43 acc. to EN 60529			
Max pressure at stem	Max. 25 bar statical			
Weight (kg)	0,22	0,27	0,33	0,56

## Options

- Scale in °F
- Second dial skale C/°F
- customised Logo
- drag pointer
- set pointer on window or dial

## Design of process connection

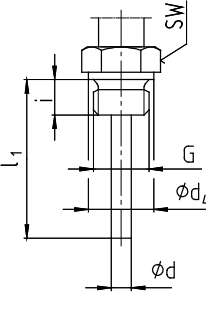
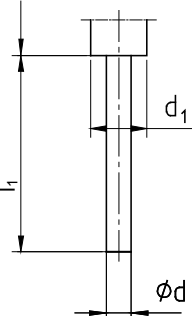
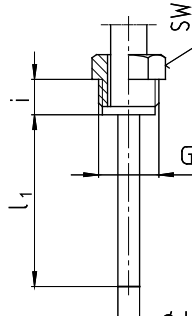
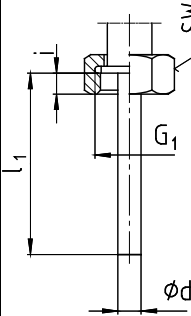
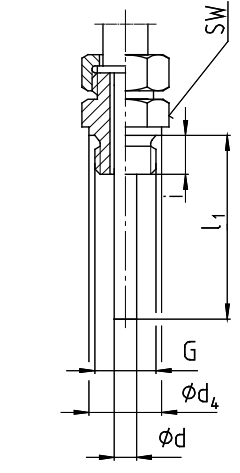
	Male thread	Plain	Male nut	Union nut	Compression fitting, sliding on stem												
Stem-length $l_1$	63 mm 100 mm 160 mm 200 mm 250 mm	45 mm 63 mm 100 mm 160 mm 200 mm 240 mm	80 mm 140 mm 180 mm 230 mm	89 mm 126 mm 186 mm 226 mm 276 mm	variable Minimum-immersion length $l_{\min} = 60 \text{ mm}$  Length $l \geq l_1 + 40 \text{ mm}$												
Dimensions																	
stem-diameter $\varnothing d$	standard 8 mm option: 6mm																
Thread and dimensions in mm		SW	d4	i		d1		SW	i		SW	i		SW	d4	i	
	G ¼	17	16	8		18		G ½	27	20	G ½	27	8,5	G ¼	17	16	8
	G ½	27	26	14				M18x1,5	24	12	G ¾	32	10,5	G ½	27	26	14
	M18x1,5	24	23	12									M18x1,5	24	23	12	
	½ NPT	22	-	19									½ NPT	22	-	19	
													¾ NPT	30	-	20	

## Dimensions (mm)

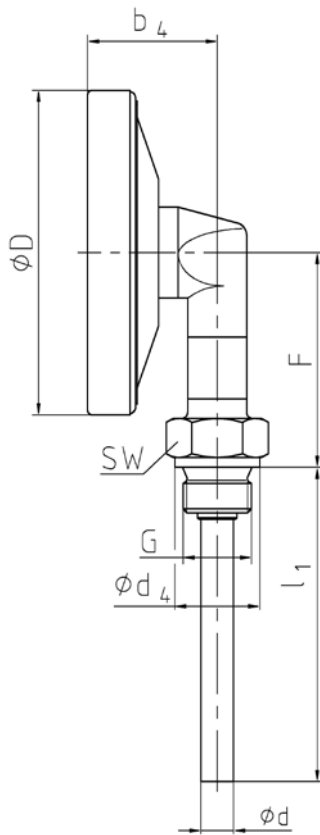

Nominal size (=ØD [mm])	b4	F
63	34 mm	47 mm
80	36 mm	56 mm
100	40 mm	66 mm
160	42,5 mm	96 mm

Other dimensions see design of process connection (page 3)